

Normandale Place

8201 Norman Center Drive | Bloomington, MN 55437



OFFICE SPACE FOR LEASE

Space Available: 2,223 - 18,290 RSF

NNN Rate: \$15.00/RSF

2025 OPEX & RE Taxes: \$11.01/RSF

Operating Expenses: \$6.73/RSF

RE Taxes: \$4.28/RSF

- Access to I-494 and Hwy 100, 169 and I-35W
- Large training room
- Break room
- Lots of natural light
- Monument signage available
- Controlled access entry system
- Foodsby
- Minutes from the MSP Airport
- Close proximity to restaurants, hotels, shopping, Caribou Coffee, and Life Time Fitness.
- Normandale Lake Park with walking and biking trail nearby.

Jeff Houg

D: 952-300-9545

M: 612-889-2242

jhoug@shcre.com

www.shcre.com



Normandale Place

8201 Norman Center Drive | Bloomington, MN 55437

Jeff Houg

D: 952-300-9545

M: 612-889-2242

jhoug@shcre.com

www.shcre.com

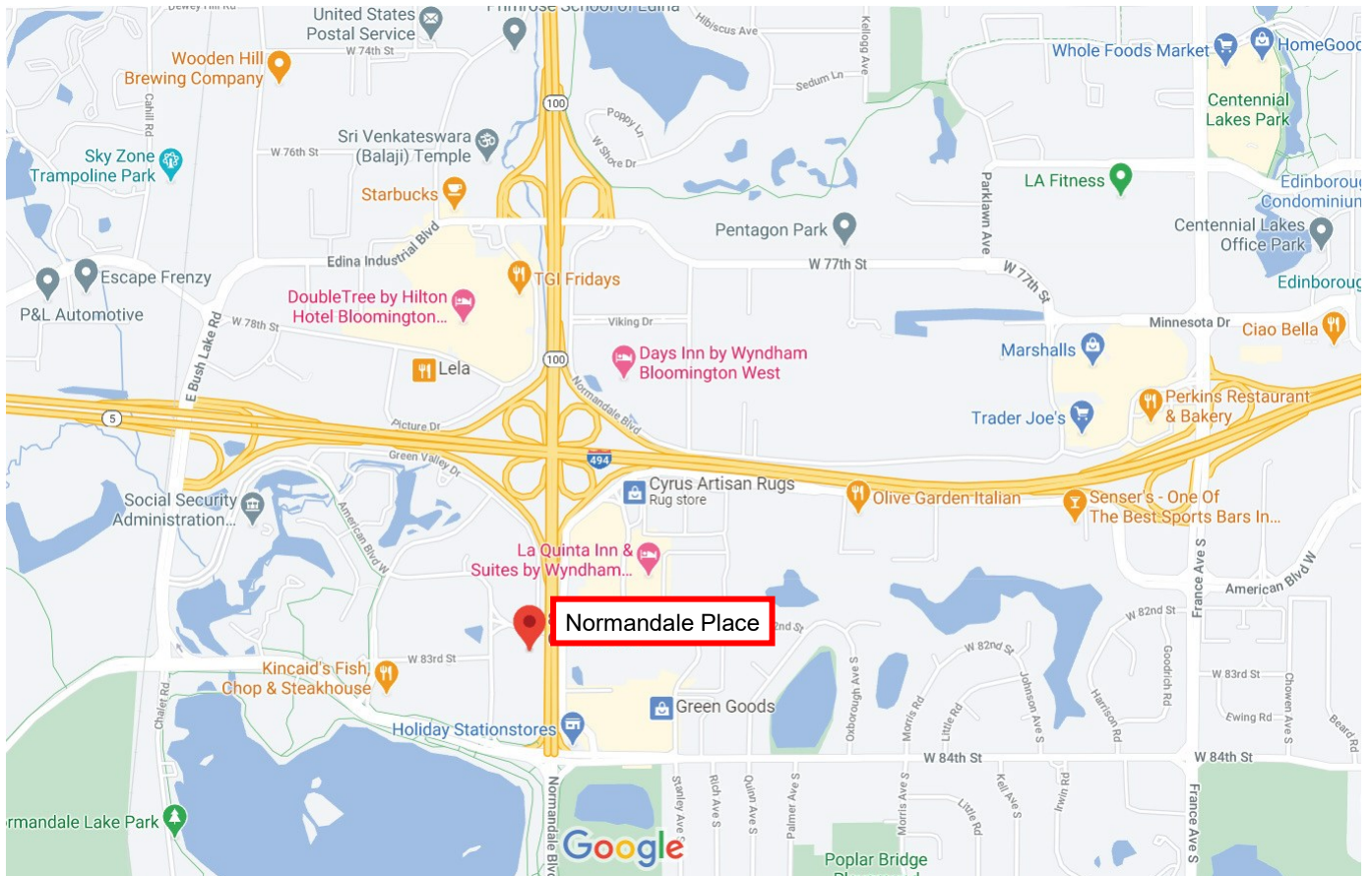

Normandale Place

8201 Norman Center Drive | Bloomington, MN 55437

Jeff Houg

D: 952-300-9545

M: 612-889-2242

jhoug@shcre.com

www.shcre.com

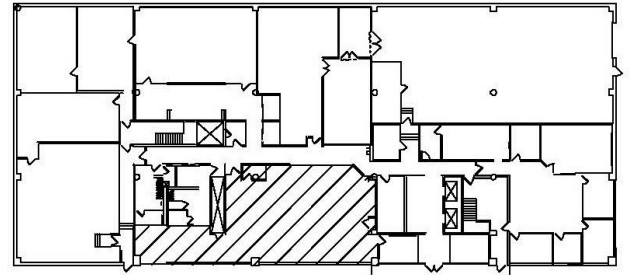

Key Plan - 1st Floor

Suite 100 - 2,545 RSF

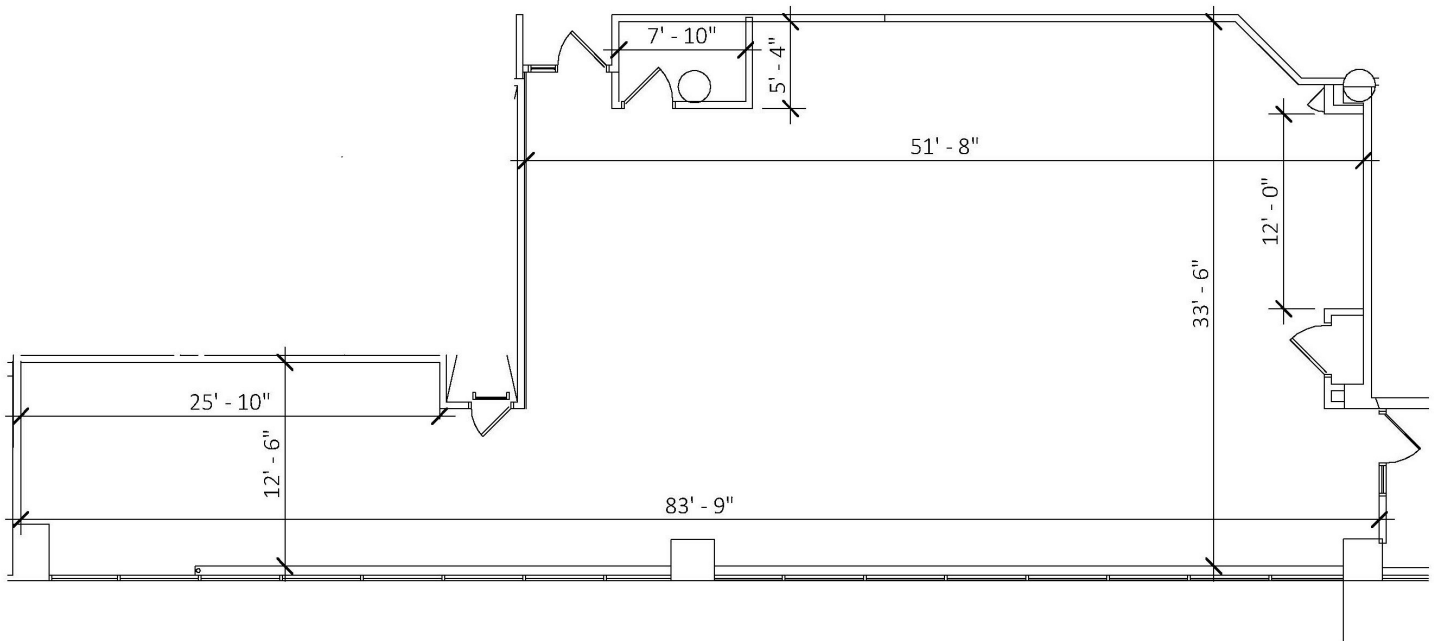

Normandale Place

8201 Norman Center Drive | Bloomington, MN 55437

Jeff Houg

D: 952-300-9545

M: 612-889-2242

jhoug@shcre.com

www.shcre.com

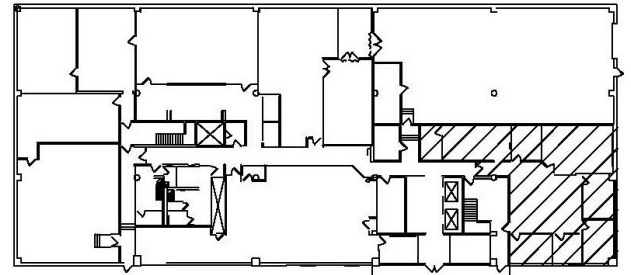

Key Plan - 1st Floor

Suite 150 - 2,568 RSF

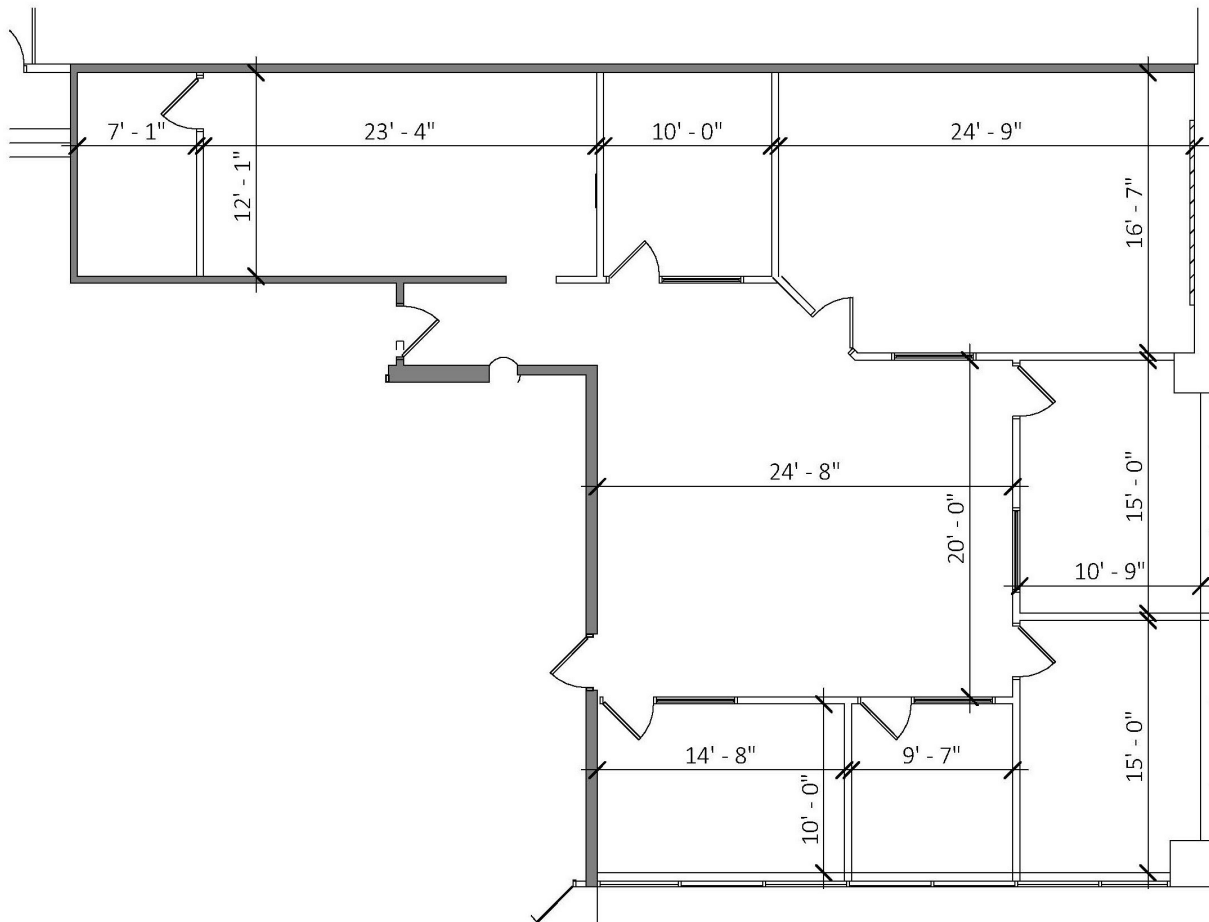

Normandale Place

8201 Norman Center Drive | Bloomington, MN 55437

Jeff Houg

D: 952-300-9545

M: 612-889-2242

jhoug@shcre.com

www.shcre.com



- Entire 3rd Floor
- Elevator Access
- Private bathrooms and shower

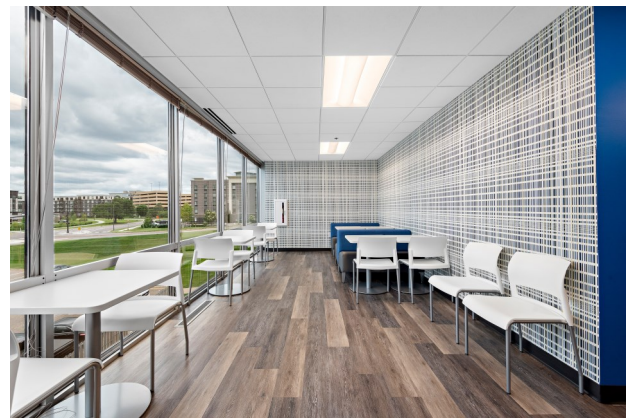

Suite 300 - 18,290 RSF

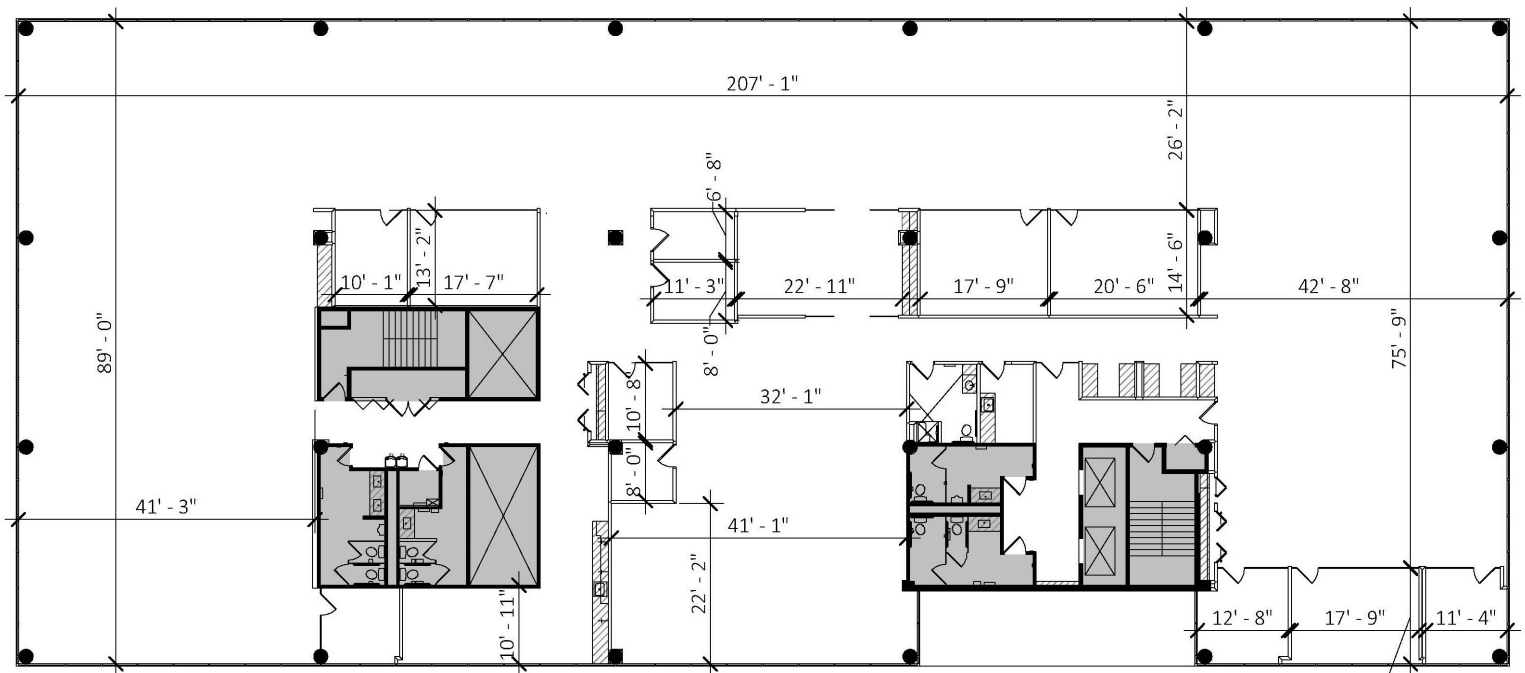

Normandale Place

8201 Norman Center Drive | Bloomington, MN 55437

Jeff Houg

D: 952-300-9545

M: 612-889-2242

jhoug@shcre.com

www.shcre.com

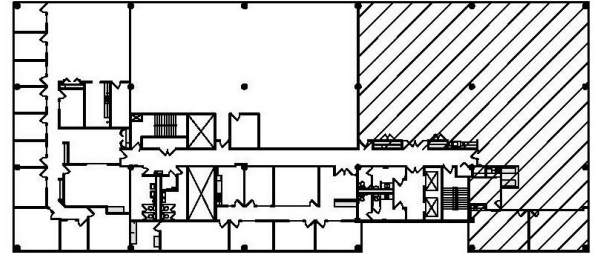

Key Plan - 4th Floor

Suite 400 - 7,021 RSF

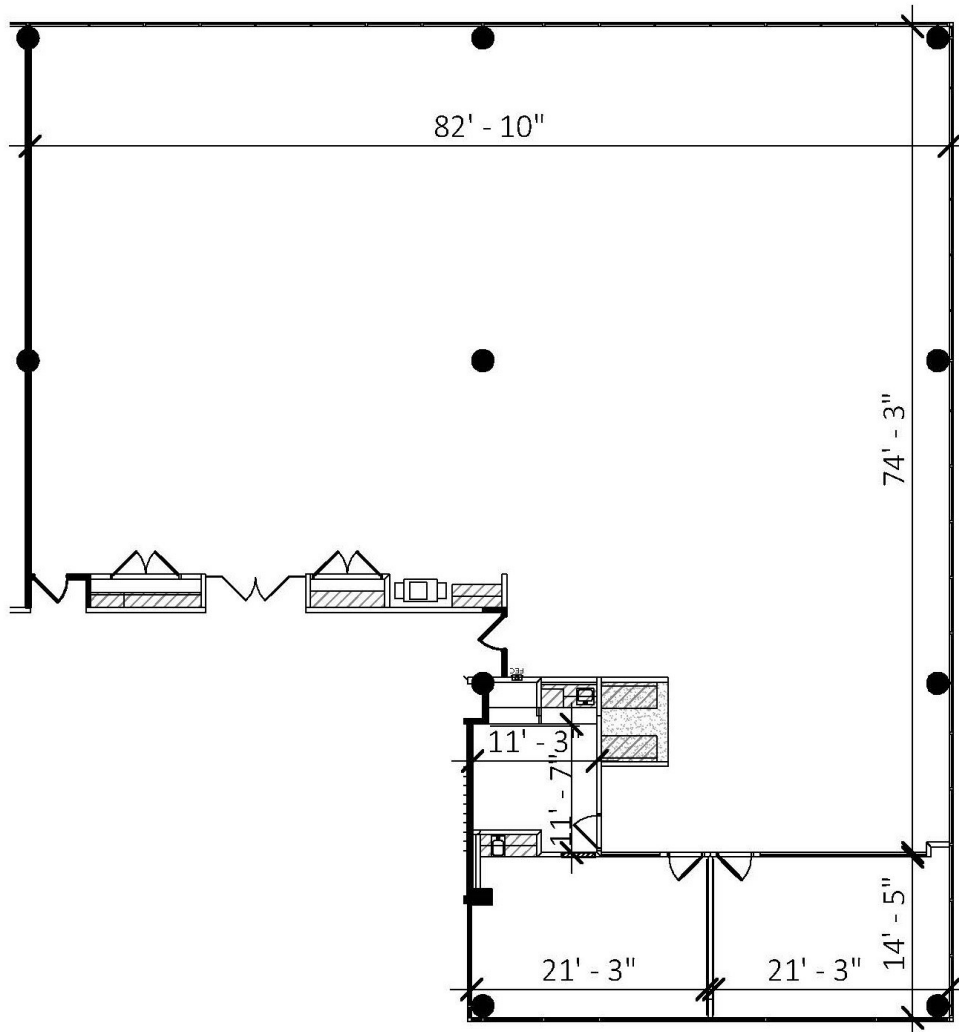

Normandale Place

8201 Norman Center Drive | Bloomington, MN 55437

Jeff Houg

D: 952-300-9545

M: 612-889-2242

jhoug@shcre.com

www.shcre.com

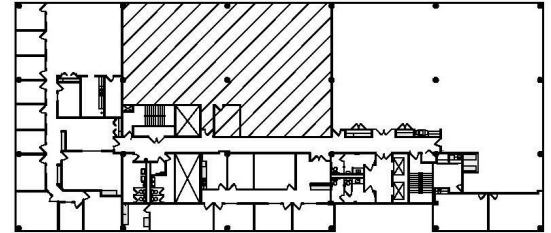

Key Plan - 4th Floor

Suite 410 - 4,635 RSF

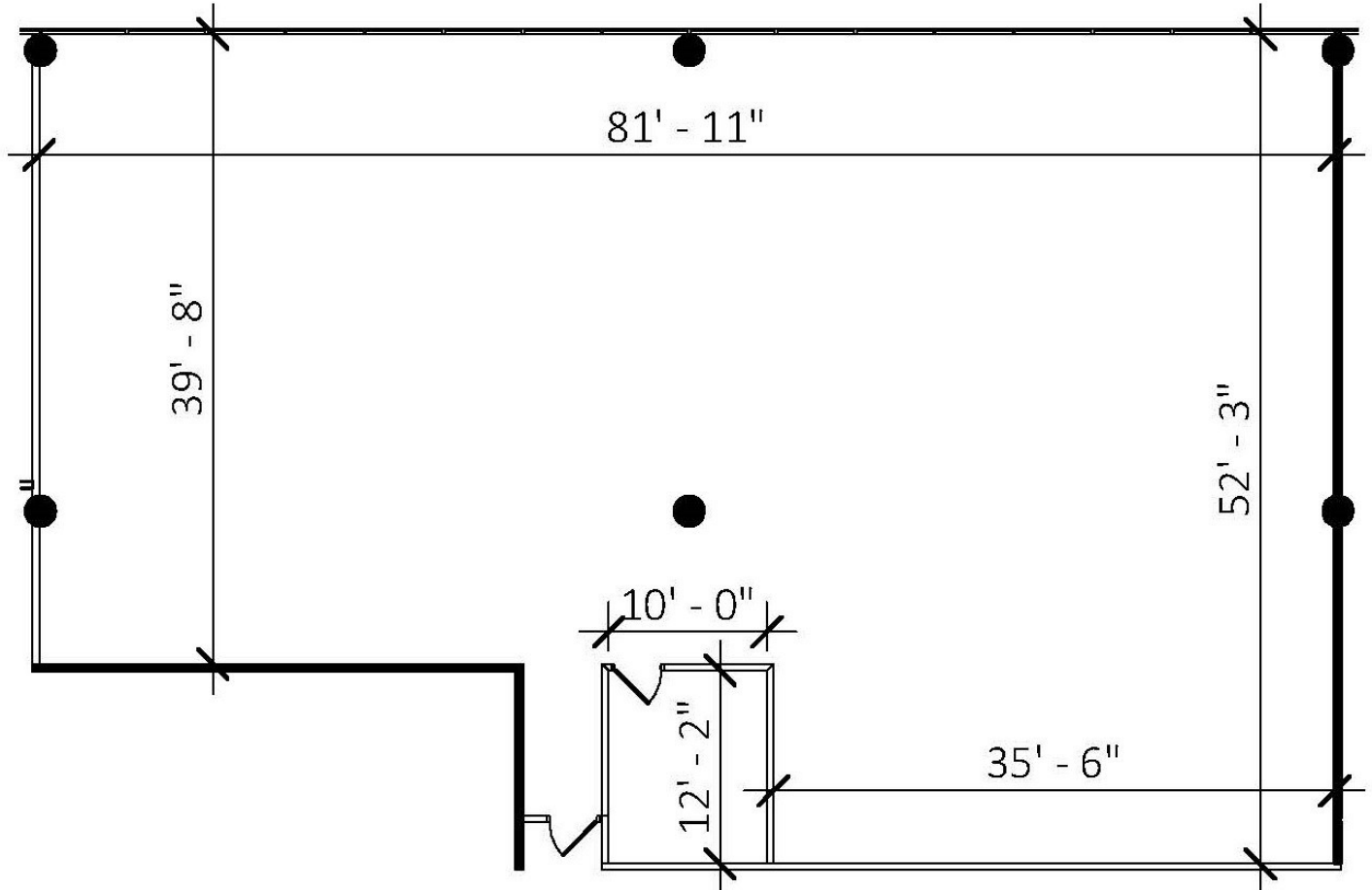

Normandale Place

8201 Norman Center Drive | Bloomington, MN 55437

Jeff Houg

D: 952-300-9545

M: 612-889-2242

jhoug@shcre.com

www.shcre.com



Suite 450- 4,418 RSF

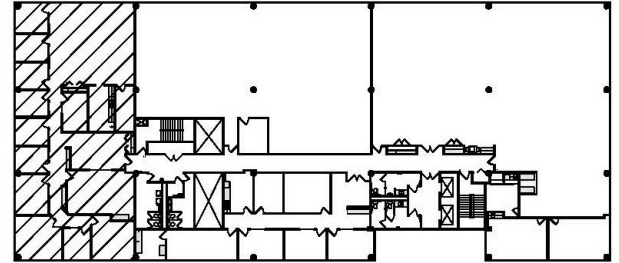

Key Plan - 4th Floor

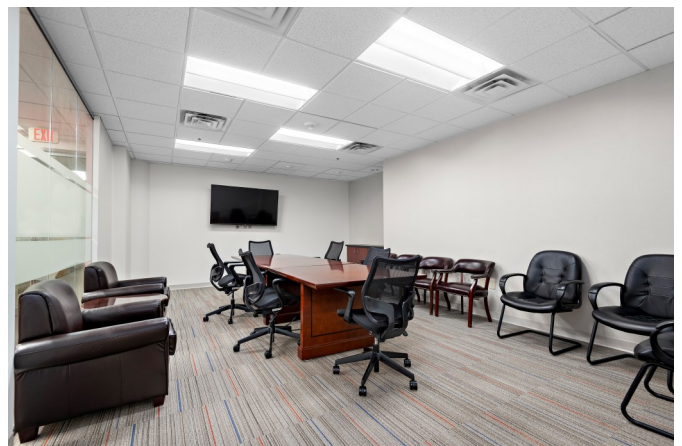
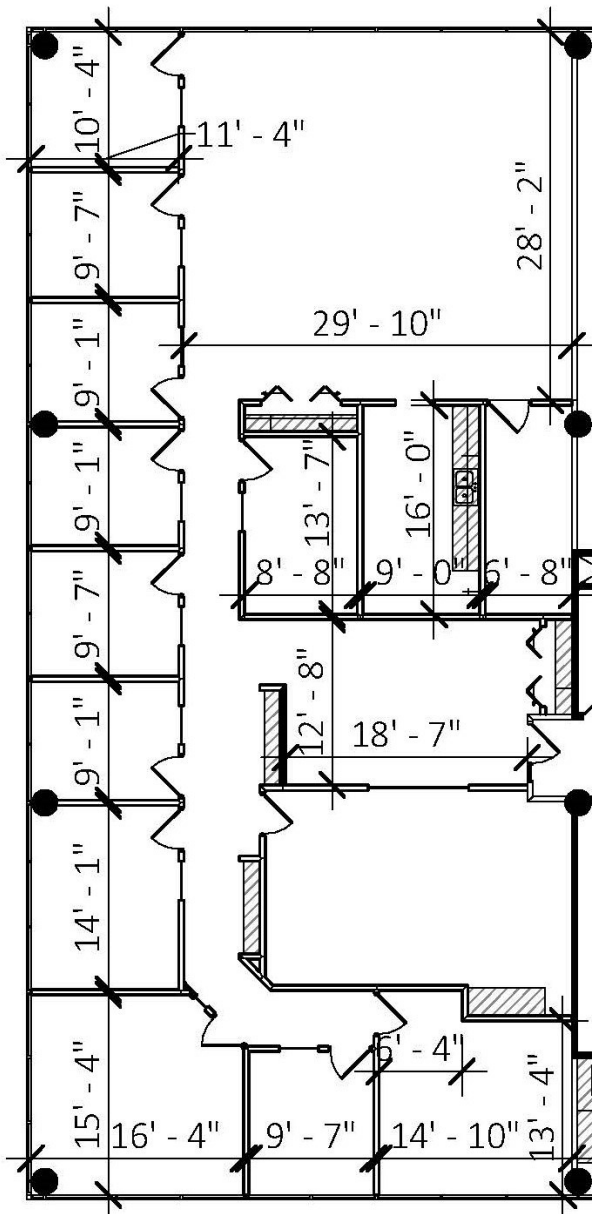

Normandale Place

8201 Norman Center Drive | Bloomington, MN 55437

Jeff Houg

D: 952-300-9545

M: 612-889-2242

jhoug@shcre.com

www.shcre.com



- Entire 5th Floor
- Elevator Access
- Private bathrooms

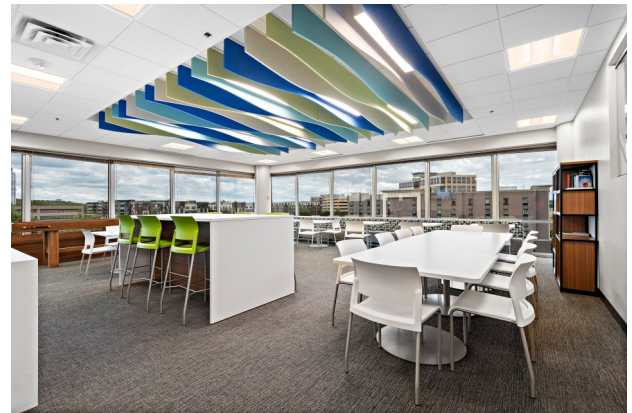

Suite 500- 18,290 RSF

